

- Internal Fuses on complete range from 30 to 800A
- 100 kA Short Circuit Current (SCCR) up to 600V
- Voltage Supply 480-600-690V
- OLED Display for easy Diagnostic & Configuration
- All Firing & Control Mode available
- Wi Fi and all popular Field Bus available
- APP for communication via Apple or Android™
- Remote Service
- Comply with EMC, cULus® 508 listed and cUL® listed

**CD AUTOMATION**

**POWERED BY INNOVATION**



***Innovation in Power Control***



[www.cdautomation.com](http://www.cdautomation.com)  
**Revo C Catalog 2021**

# WITH REVO C "YOU WILL NEVER BE ALONE"

## CD AUTOMATION OFFERS REMOTE SERVICE SUPPORT FROM ANYWHERE IN THE WORLD VIA SMARTPHONE APP

### Wide range of communication protocols:

Keep your REVO C connected with the outside world via popular protocols including Modbus® RTU, Ethernet TCP, Profibus®, Profinet® plus WiFi and USB port for local data transfer.

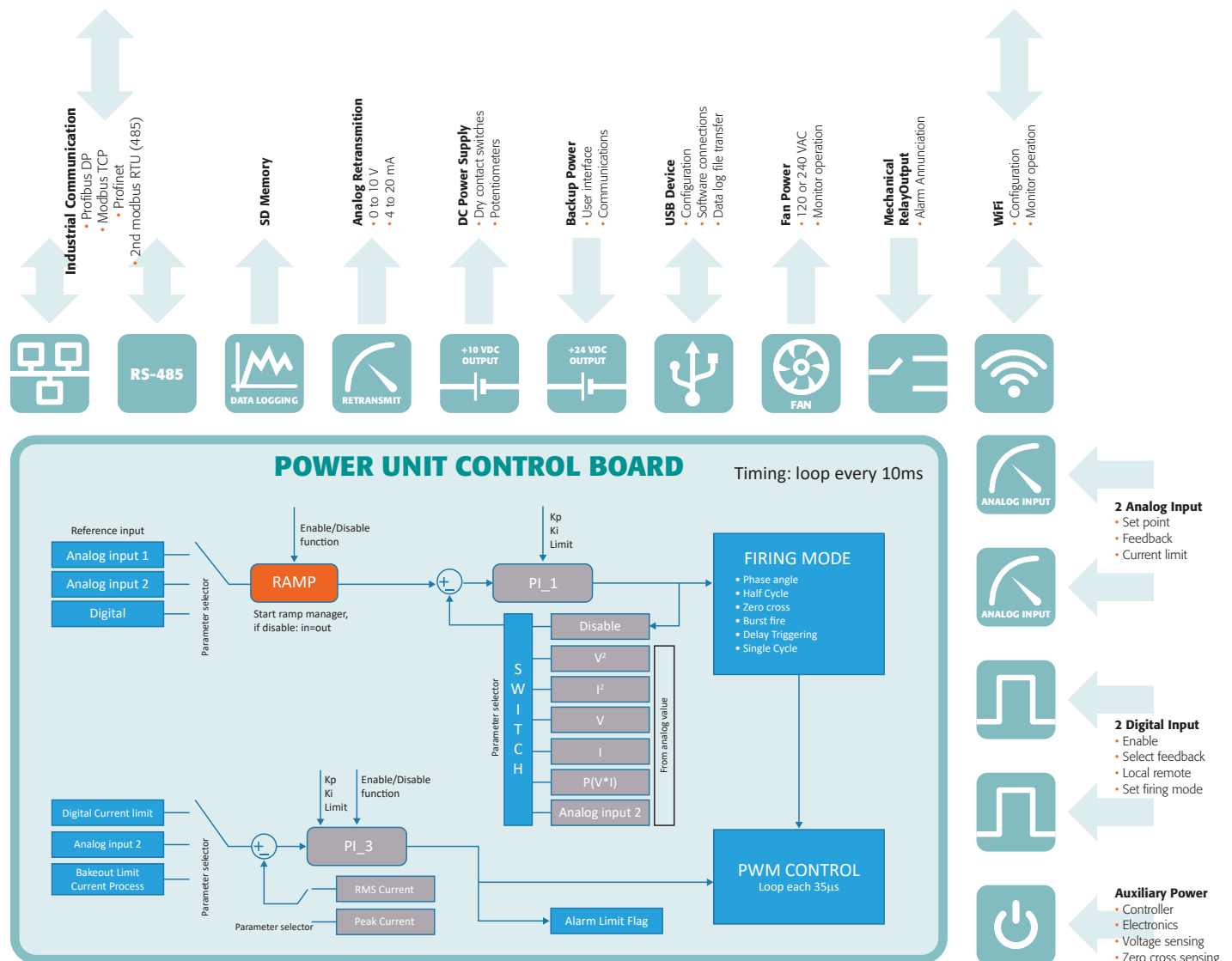

# CONNECTIVITY AND CONFIGURATION

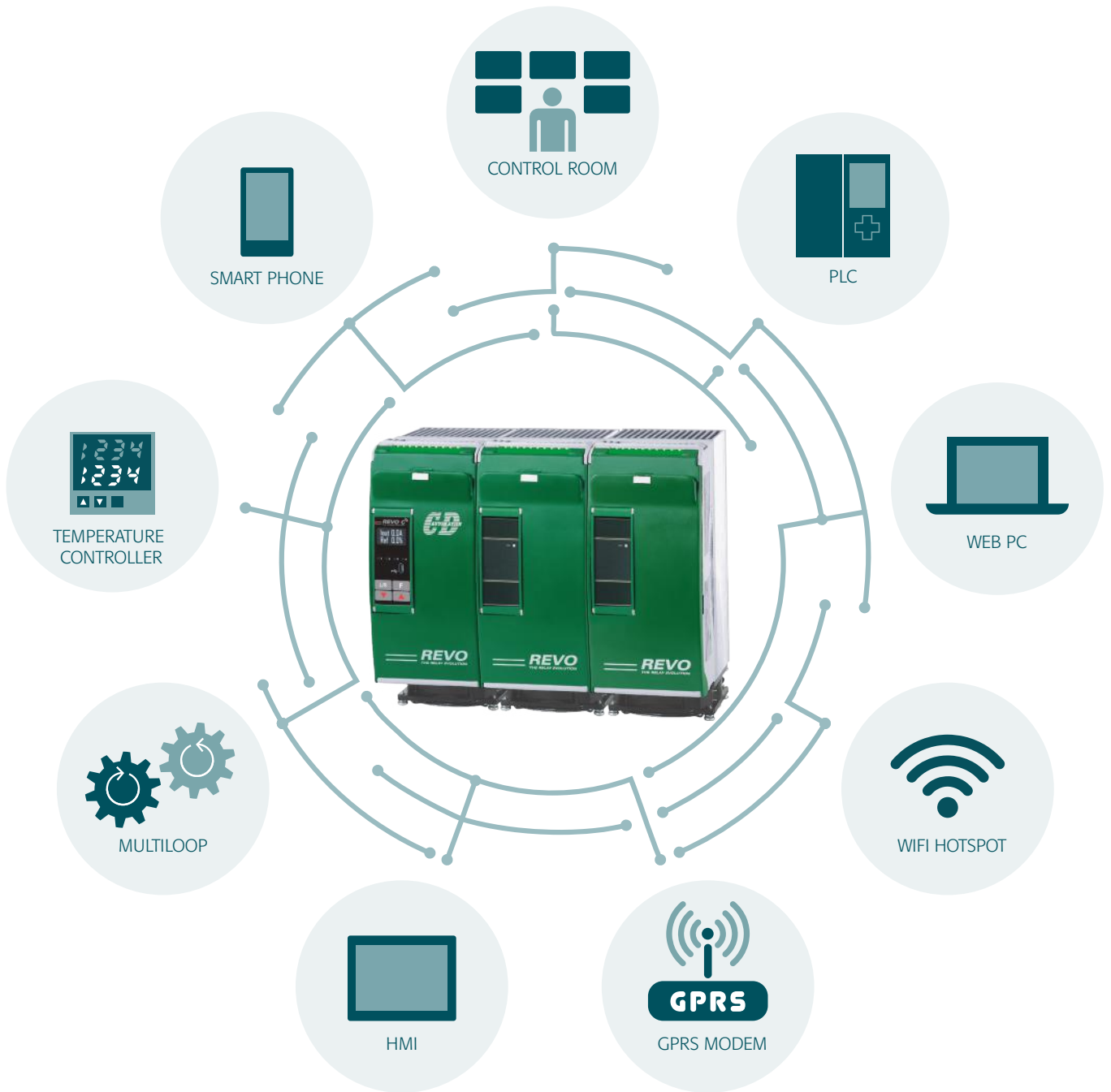

READ	WRITE
Set Point	Set Point
Alarm	Configuration Parameters
Voltage	
Power	
Current	
Heater Break Alarm	
SCR Short Circuit Alarm	

# CD AUTOMATION CONNECT APP DOWNLOAD IT FREE OF CHARGE

## YOU WILL NEVER BE ALONE...

### ..WE GIVE YOU OUR REMOTE APP SERVICE!

#### THE CD AUTOMATION APP WILL WORK WITH BOTH APPLE AND ANDROID SYSTEMS

Shown are a few of the most important screen shots that provide key process information, easy product setup and product remote control:

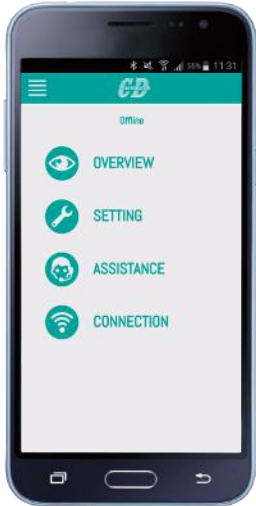

**APP Download:** Go to Google Play Store or Apple Store and download "CD Automation Connect" app.

**Monitor:** You can monitor the status of the REVO-C by selecting the Overview screen.

**Configuration:** Configure your unit by selecting the Setting menu, choose your load connection and simply download.

**Remote Service:** Need assistance? Download the configuration, add any comments and email automatically. Our engineers will respond with recommendations.

**Connection:** You can also enable or disable Wi-Fi if required.



**Overview:** The Overview menu allows you to view key data from outside the cabinet:

**Status:** RUN, ON, DI.1, DI.2.

**Alarms:** SC, short Circuit of one or both Thyristors.

HB, for partial or total Load Failure with capacity to diagnose failure of one element over 5 in parallel.

TH, Thermal temperature of Heat Sink in Alarm conditions.

CL, Current Limit active.

**Values:** Voltage and Current in Engineering units with % Power indication.

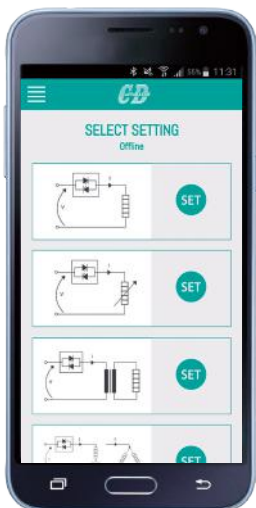

**Setting:** Easily configure your unit with just two key presses.

Scroll to the icon that represents your load type and press the SET key and the unit will load specific parameter values matched to your process.

Load types include normal and cold resistance plus primary controlled transformer loads.

**Remote Control:** From this page you can take control of the process from outside the cabinet:

- Values: Voltage and Current in Engineering units with % Power indication.
- Enable and Disable the REVO C.
- Local / Remote facility.
- % Power (value adjustable).
- Current Limit Set Point.
- Current Limit value in amps and in %.



# CONFIGURATOR SOFTWARE

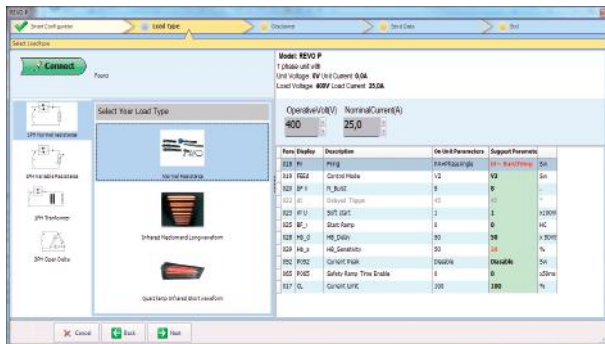

## FAST TUNE

The all new powerful Thyristor Configurator Software allows you to configure all CD Automation products quickly and easily by using the FAST MODE. Simply select your application and the load type picture appears automatically, providing a list of suggested parameter settings. Depending on your application requirements, you can accept or make manual adjustments and when ready, download direct to the thyristor unit.

## TEST UNIT

The TEST page is very useful when installing & commissioning CD Automation products as well as finding process issues or fine tuning at a later stage.

You can read, write, enable and disable key values and parameters to test your load. Examples include; reading voltage, current and power values, or current limit status, changing input types between analog or SSR, control (feedback) modes V, I and VxI, or select firing types half cycle, single cycle, burst firing, delayed triggering, phase angle and soft start.

The new 'Load Analyzer' (a small oscilloscope) can be activated from this page, see below.

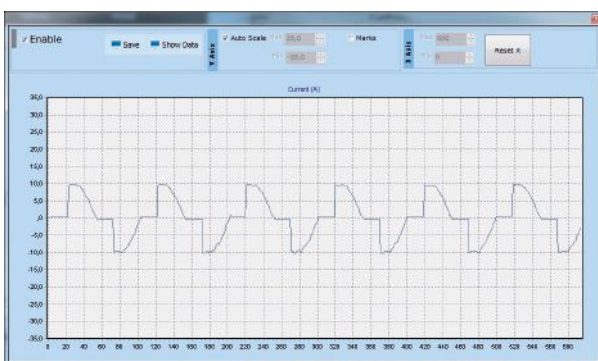
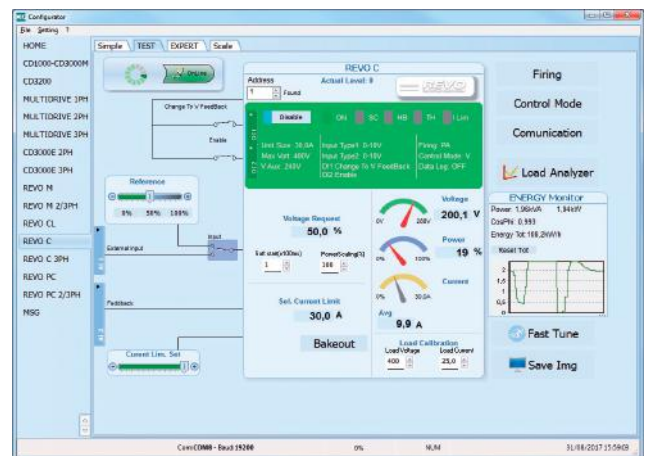

## LOAD ANALYZER

Provides real-time information of the output waveform, where you can select up to 10 process variables to help the operator determine if the waveform is in line with process expectations. Also useful for trouble shooting.

## PROCESS VARIABLE LOGGING

In REVO C Storage: 16GB SD Memory Card with programmable Logging Intervals. Estimated storing 10 years.

On other CD Automation Products the logging intervals are a fix value.



# REVO C FEATURES AND DIMENSIONS

		DESCRIPTION	REVO C 1PH		REVO C 2PH		REVO C 3PH	
		CODE	RC1	RC2	RC2	RC3	RC3	
LOAD TYPE	Max voltage 480V		●		●		●	
	Max voltage 600V		●		●		●	
	Max voltage 690V		●		●		●	
	Single phase		●					
	3 phase load star no neutral or delta				●		●	
	3 phase load star with neutral						●	
	3 phase load open delta		● <sup>(1)</sup>					
INPUT TYPE	SSR 4:30VDC		●		●		●	
	4:20 mA		●		●		●	
	0:10 Vdc		●		●		●	
	Potentiometer		●		●		●	
FIRING	Single Cycle		●					
	Half Cycle		●					
	Burst Firing		●		●		●	
	Phase Angle		●				●	
	Delayed Triggering		●				●	
	Zero Crossing		●		●		●	
CONTROL MODE	Open Loop		●		●		●	
	Voltage		●		●		●	
	Voltage square		●		●		●	
	Current		●		●		●	
	Current Square		●		●		●	
	Power V x I		●		●		●	
OPTIONS	Current Limit CL		○				○	
	Heater Break Alarm + SCR Short Circuit		○		○		○	
	WiFi		○		○		○	
	Logging		○		○		○	
	Totalizer		○		○		○	
COMM.	Modbus® RTU		○		○		○	
	Profibus® DP + 1 Modbus® RTU		○		○		○	
	2 Profinet® IO + 1 Modbus® RTU		○		○		○	
	2 Modbus® TCP + 1 Modbus® RTU		○		○		○	
CURRENT		<b>CURRENT</b>	<b>SIZE</b>		<b>SIZE</b>		<b>SIZE</b>	
			600V Max	690V	600V Max	690V	600V Max	690V
		30	SR9		SR10		SR11	
		35	SR9		SR10		SR11	
		40	SR9		SR10		SR11	
		60	SR12	S11	SR13	S11	SR14	S11
		90	SR15	S11	SR16	S11	SR17	S11
		120	SR15	S11	SR16	S13	SR17	S13
		150	SR15	S11	SR16	S13	SR17	S13
		180	SR15	S11	SR16	S13	SR17	S13
		210	SR15	S11	SR16	S13	SR17	S13
		300	S12		S14	S14	S14	S14
		400	S12	S12	S14	S14	S14	S14
		450			S14	S14	S14	S14
		500	S12	S12	S14	S14	S14	S14
		600	S12	S12	S14	S14	S17*	S17
		700	S12	S12	S14	S14	S17*	S17
		800	S15*	S15	S16*	S16	S17*	S17
		1100	SR18*	SR18	SR19*	SR19	SR20*	SR20
		1400	SR21*	SR21	SR22*	SR22	SR23*	SR23
		1600	SR21*	SR21	SR22*	SR22	SR23*	SR23
	1800	SR21*	SR21	SR22*	SR22	SR23*	SR23	
	2100	SR21*	SR21	SR22*	SR22	SR23*	SR23	

● Standard ○ Option ■ CE standard + cUL® as an option ■ CE Only - **Note (1):** Use n° 3 Revo-C 1PH \*UL approval as option

Agency Approval and Regulatory: cULus 508 Listed File E231578; cUL® Listed to C22.2 No. 14; CE EMC Directive 2014-30-EU, EN 60947-4-3 Class A Emissions; CE Safety Directive 2014-35-EU, EN 60947-4-1, -4-3; RoHS 2011-65-EU; W.E.E 2012-19-EU

# GLOSSARY

## ZERO CROSSING ZC

ZC firing mode is used with the logic output from a temperature controller and so the thyristor operates like a contactor. The cycle time is performed by the temperature controller. Zero Crossing minimizes interferences as the thyristor unit switches ON-OFF at zero voltage.

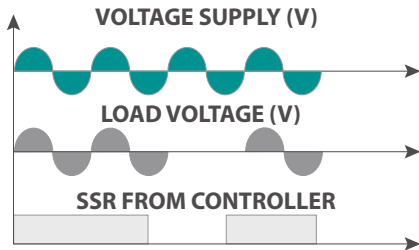

## BURST FIRING BF

This firing is performed digitally within the thyristor unit at zero volts, producing no EMC interferences. Analogue input is necessary for BF and the number of complete cycles must be specified for 50% power demand. This value can be between 1 and 255 complete cycles, determining the speed of firing. When 1 is specified, the firing mode becomes Single Cycle (SC).

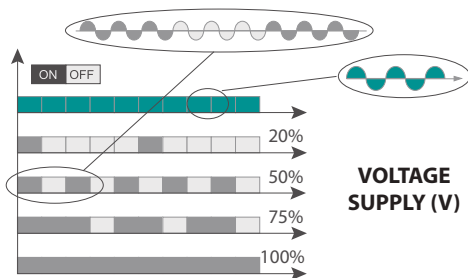

Soft Start + Burst Firing now available as an option.

## SINGLE CYCLE SC

SC is the fastest zero crossing switching method. At 50% input signal, one cycle is ON and one cycle is OFF. At 75%, 3 cycles are ON and one cycle is OFF. If power demand is 76% the unit performs the same as for 75% but every time the unit switches ON the microprocessor divides 76/75 and memorises the ratio. When the sum is one the unit delivers one cycle more to the load. With this firing it is necessary to have analogue input.

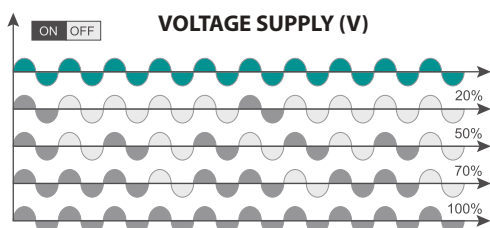

## HALF CYCLE

This is a super Fast Firing used with short infrared elements to avoid flickering and harmonic generated by Phase Angle Firing.

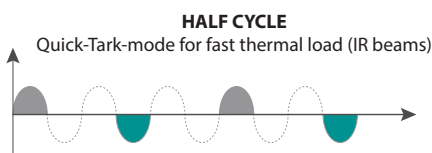

## DELAYED TRIGGERING DT

Used to switch the primary coil of transformers when coupled with normal resistive loads (not cold resistance) on the secondary, DT prevents the inrush current when zero voltage (ON-OFF) is used to switch the primary. The thyristor unit switches OFF when the load voltage is negative and switches ON only when positive with a pre-set delay for the first half cycle.

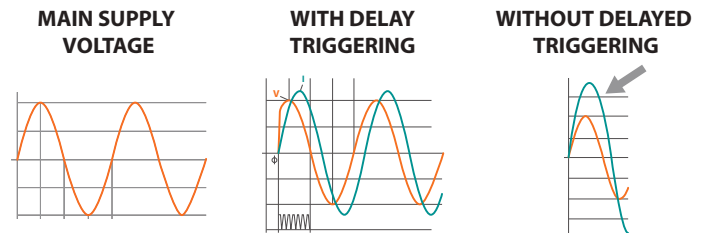

## PHASE ANGLE PA

PA controls the power to the load by allowing the thyristor to conduct for part of the AC supply cycle only. The more power required, the more the conduction angle is advanced until virtually the whole cycle is conducting for 100% power. The load power can be adjusted from 0 to 100% as a function of the analogue input signal, normally determined by a temperature controller or potentiometer, PA is normally used with inductive loads.

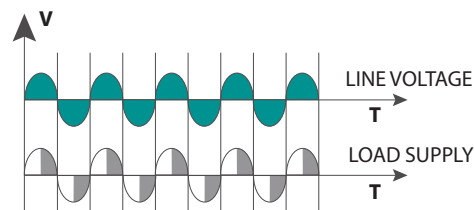

## FEEDBACK/CONTROL MODE

Supply voltage fluctuations changes the power to the load. To overcome this effect the voltage supplied to the load is measured and compared with the power demand from the controller. The error signal is used to automatically hold the power at the value requested.

Three types of control mode are available:

- Voltage Control Mode, where the input signal is proportional to the voltage output (voltage f/b).
- Current Control Mode, where the input signal is proportional to the current output (current f/b).
- Power Control Mode, where the input signal is proportional to the power output (power f/b).

As an option it is possible to transfer control mode from voltage to power via a simple digital command.

# REVO C FAMILY SIZE AND DIMENSIONS

REVO Connect is a fully universal product range based upon powerful microprocessor technology. Available from 30A to 2100A and single phase (1PH) plus 2PH & 3PH to drive 3 phase loads, its key benefit is its connectivity with the outside world, through Wi-Fi and the most popular Field Bus Protocols. Its universality allows inputs, all firing and control modes to be configured via Smart phone using CD Automation's Connect-APP or via your personal computer and CD Automation's Configurator Software.

CD Automation's APP and Configurator Software are available free of charge.

**When you buy REVO-C, you also buy CD Automation's experience and know-how to drive your application.**



**SR9** H 121 x W 72 x D 185 - 1,15kg.



**SR10** H 121 x W 108 x D 185 - 1,76kg.



**SR11** H 121 x W 144 x D 185 - 2,4kg.



**SR12** H 269 x W 93 x D 170 - 3,4kg.

**SR15** H 273 x W 93 x D 170 - 3,6kg.



**SR13** H 269 x W 186 x D 170 - 6,8kg.

**SR16** H 273 x W 186 x D 170 - 7,0kg.



**SR14** H 269 x W 279 x D 170 - 10,2kg.

**SR17** H 273 x W 279 x D 170 - 10,6kg.



**S11** H 440 x W 137 x D 270 - 10,5kg.



**S12** H 520 x W 137 x D 270 - 15kg.



**S13/S14** H 440/520 x W 262 x D 270 - 18/22kg.



**S15** H 560 x W 137 x D 270 - 17,2kg.



**S16** H 560 x W 275 x D 270 - 34,4kg.



**S17** H 560 x W 411 x D 270 - 51,6kg.





**SR18** H 550 x W 329 x D 347 - 27kg.



**SR19** H 550 x W 523 x D 347 - 49kg.



**SR20** H 550 x W 717 x D 347 - 72kg.



**SR21** H 730 x W 329 x D 347 - 34kg.



**SR22** H 730 x W 523 x D 347 - 65kg.



**SR23** H 730 x W 717 x D 347 - 98kg.



## APPLICATIONS

- Petrolchemicals
- Platform for oil extraction
- Conventional power generator
- Chemicals and pharmaceuticals
- Autoclaves
- Electric Furnaces
- Galvanic process
- Glass industry
- Polysilicon
- Chemical
- Plastic Machinery
- Packing Machinery
- Automobile
- Paint drying
- UV drying
- Car internal fittings

# FEATURES AND BENEFITS

## TRADITIONAL SYSTEM

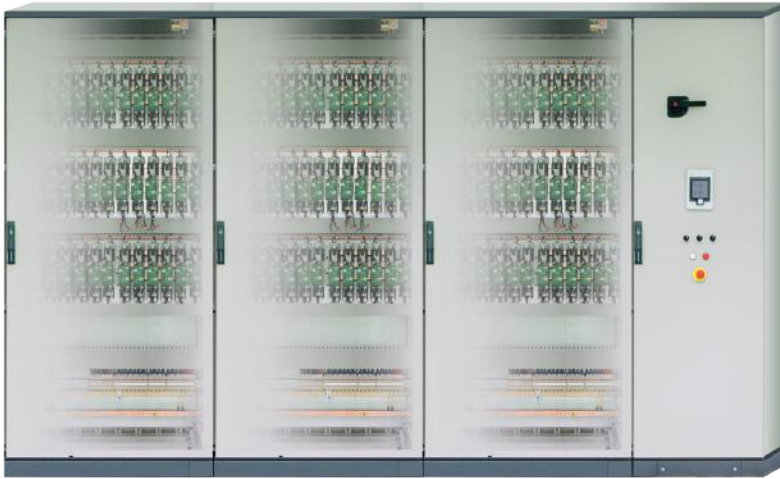

## REVO C SYSTEM



### REVO C POWER CONTROLLER RANGE

Current Range from 30 to 2100A

Controlled Phases 1-2 or 3 Phases suitable to drive Normal Resistance, Cold Resistance and transformers

Voltage 480V, 600V and 690V

### FEATURES AND BENEFITS

Integrated with every REVO-C is the semiconductor fuses, thyristors and current transformers. Designed and built as a single unit not only helps reduce the overall space and labour time to mount and connect separate fuses but also ensures that all testing is carried out correctly and guaranteed to the figures stated. The 100 KA short circuit current rating (SCCR) is very important and complies fully with NEC 110.10 regulation. Full documentation available upon request.

- Robust SCR designed to meet rugged industrial environments
- Easy access to fuses and thyristors by simply opening front panel door
- Circuit boards are mounted directly to the front panel door for easy access
- cUL 508 Listed up to 700A included, and UL listed up to 2100A

### OUR PRODUCT DIMENSIONS ARE SMALL BECAUSE WE HAVE:

- Fuses mounted inside the thyristor unit
- Our heat sinks have a very high efficiency thermal resistance (low value °C/W)
- Internal fuses results in longer heat sinks and increased heat sink efficiency
- Improved air ventilation aids fuse cooling







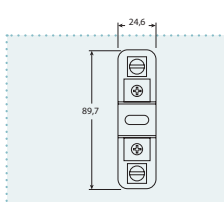

# THE CHOICE IS INTERNAL OR EXTERNAL FUSES?

## POWER CONTROL UNIT WITH INTERNAL FUSES

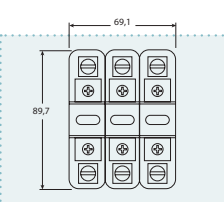
- Up to 60% space saving
- Fuse I2t value selected by CD Automation
- SCCR Approved - 100 KA short circuit current rating valid and tested
- Save time for wiring between fuse holder and thyristor power control unit
- Your cabinet become 60% less in dimension and price

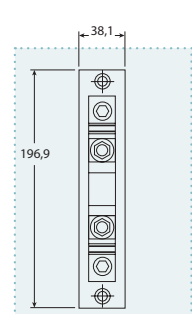
## POWER CONTROL UNITS WITH EXTERNAL FUSE AND FUSE HOLDER

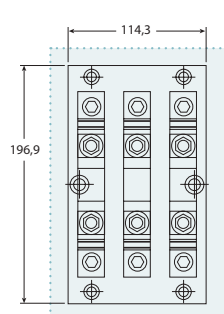
- More cabinet space required
- Bigger cabinet, more space required in the factory
- Do you know how much the extra space will cost you?
- If the product dimensions are twice as big, you will need twice the factory space

FUSEBLOCK DIMENSION			
<p>UP TO 40A COMPETITOR 1 PHASE</p>  <p>COMPETITOR TOTAL AREA 616 cm<sup>2</sup></p> <p>EXTERNAL FUSES</p>	<p>UP TO 40A CD AUTOMATION 1 PHASE</p> <p>CD AUTOMATION TOTAL AREA 100 cm<sup>2</sup></p>  <p>INTERNAL FUSES</p>	<p>UP TO 40A COMPETITOR 1 PHASE</p>  <p>COMPETITOR TOTAL AREA 616 cm<sup>2</sup></p> <p>EXTERNAL FUSES</p>	<p>UP TO 40A CD AUTOMATION 1 PHASE</p> <p>CD AUTOMATION TOTAL AREA 175 cm<sup>2</sup></p>  <p>INTERNAL FUSES</p>
<p>UP TO 160A</p>  <p>COMPETITOR TOTAL AREA 616 cm<sup>2</sup></p> <p>EXTERNAL FUSES</p>	<p>UP TO 210A</p> <p>CD AUTOMATION TOTAL AREA 250 cm<sup>2</sup></p>  <p>INTERNAL FUSES</p>	<p>UP TO 200A</p>  <p>COMPETITOR TOTAL AREA 899 cm<sup>2</sup></p> <p>EXTERNAL FUSES</p>	<p>UP TO 210A</p> <p>CD AUTOMATION TOTAL AREA 762 cm<sup>2</sup></p>  <p>INTERNAL FUSES</p>

# REVO C 1PH



SIZE SR9



SIZE SR15



SIZE S12

## Technical Specification

- Dimensions:** See size and dimensions page 8-9
- Load type:** Normal Resistance, Infrared Short, Medium and Long, Transformer Primary, Cold resistance and SiC elements
- Inputs:** 4:20mA, 0:10V, SSR and ModBus as std and different Field Bus Listed in the Product Coding
- Firing mode:** Half Cycle, Single Cycle, Burst Firing, Delayed Triggering, Phase Angle with or without Soft Start
- Control Mode:** Voltage, Current and Power or V2 and I2 with additional Transfer to VxI
- Communication:** RS485 port. RTU Modbus® Protocol and other Field Bus available
- USB:** port integrated for configuration in safety mode (No Load and Auxiliary Voltage needed) Unit Powered Through USB
- 100 KA:** Short Circuit Current rating (SCCR) up to 600V
- Approvals:** Comply with EMC, cULus® 508 listed and cUL® listed
- Dual Current Limit:** for peak and RMS value

## Option

- See below the types of options and their combination for Code generation
- Energy Totalizer
- Data Logging
- WiFi
- HB Alarm to diagnose partial or Total Load Failure and Thyristor Short Circuit

## Tools

- A very easy and Powerful Configurator Software is available Free of Charge on [www.cdautomation.com](http://www.cdautomation.com)
- CD Automation APP is also available free of charge to communicate via Wi-Fi

No option     Option selected (ex code 3: Logging + Totalizer)

I LIMIT	HB	WIFI	LOGGING	TOTALIZER	CODE	NOTES
					Ø	
					1	
					2	
					3	
					4	
					5	
					6	
					7	
					8	
					9	
					A	
					B	
					C	
					D	
					E	
					F	
					G	
					H	
					I	
					J	
					K	
					L	
					M	
					N	
					O	
					P	
					Q	
					R	
					S	
					T	
					U	
					V	

**I LIMIT (CURRENT LIMIT)** This option is used to keep the overcurrent inside set limit. It's necessary to drive primary transformers and cold resistance. It's dual limit for peak and RMS value.

**HB** Alarm for partial or total load failure and Short Circuit on SCR (relay output).

**WiFi** Option that allows communication with a smart phone. From your smart phone via the CD Automation App, direct to your thyristor unit in the cabinet to read current, voltage, power and energy totalization as well as the ability to change parameters to improve process and product quality without opening the cabinet door.

**APP** Free of charge download it from Google Play or Apple Store.

**DATA LOGGER** This feature is important to see the historical data of parameter like Current, Voltage and Power and can be useful to diagnose a fault.

**ENERGY TOTALIZER** This function totalize the energy consumption of the load allowing the calculation of heating treatment.

# CONNECTIVITY

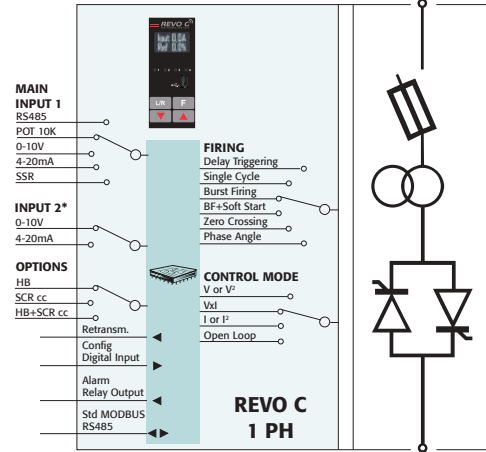

## ORDER CODE:

	<b>1</b>	<b>2</b>	<b>3</b>	<b>4</b>	<b>5</b>	<b>6</b>		<b>7</b>	<b>8</b>	<b>9</b>	<b>10</b>	<b>11</b>	<b>12</b>	<b>13</b>	<b>14</b>	<b>15</b>	<b>16</b>
<b>REVO C 1PH</b>	<b>R</b>	<b>C</b>	<b>1</b>	-	-	-	-	-	-	-	-	-	-	-	-	-	-

CURRENT		FUSES		4	5	6
description	description	code	note			
30A	Fuse + Fuse Holder Included	0 3 0				
35A	Fuse + Fuse Holder Included	0 3 5				
40A	Fuse + Fuse Holder Included	0 4 0				
60A	Fixed Fuses Included	0 6 0				
90A	Fixed Fuses Included	0 9 0				
120A	Fixed Fuses Included	1 2 0				
150A	Fixed Fuses Included	1 5 0				
180A	Fixed Fuses Included	1 8 0				
210A	Fixed Fuses Included	2 1 0				
300A	Fixed Fuses Included	3 0 0				
400A	Fixed Fuses Included	4 0 0				
500A	Fixed Fuses Included	5 0 0				
600A	Fixed Fuses Included	6 0 0				
700A	Fixed Fuses Included	7 0 0				
800A	Fixed Fuses Included	8 0 0	5			

For Extended version (from 1100A to 2100A) see page 18

MAX VOLTAGE		7
description	code	note
480V	4	
600V	6	
690V	7	1, 2

MAIN SUPPLY VOLTAGE		AUX VOLTAGE RANGE		8
		V range	code	note
100/120Vac	90 to 135Vac	1	3	
200/208/230/240Vac	180 to 265Vac	2	3	
277Vac	238 to 330Vac	3	3	
380/415/480Vac	342 to 528Vac	5	3	
600Vac	540 to 759Vac	6	3	
690Vac	540 to 759Vac	7	3	

MAIN INPUT		9
description	code	note
SSR	S	
0:20mA	B	
4:20mA	A	
0:10V	V	
10KPot	K	

FIRING		START OPTION		10
description	description	code	note	
Single Cycle	No Soft Start	C		
	Linear Soft Starter	S		
Half Cycle	No Soft Start	H		
	Linear Soft Starter	L		
Burst Firing	Soft Start for short Infr. Lamp	I		
	No Soft Start	B		
Phase Angle	Linear Soft Starter	J		
	No Soft Start	P		
Delayed Triggering	Linear Soft Starter	E		
	No Soft Start	D		
Zero Crossing	Linear Soft Starter	T		
	No Soft Start	Z		
	Linear Soft Starter	R		

CONTROL MODE		11
description	code	note
Open Loop	0	
Voltage	U	
Voltage Square	Q	
Current	I	
Current Square	A	
Power Vxl	W	

OPTION		12
description	code	note
No Option	0	
Option code - see previous page table	...	

FAN VOLTAGE		13
description	code	note
No Fan < 90A 480V/600V	0	
Fan 115Vac ≥ 90A 480V/600V - ≥ 60A 690V	1	
Fan 230Vac ≥ 90A 480V/600V - ≥ 60A 690V Std Version	2	
Fan 24Vdc ≥ 90A 480V/600V - ≥ 60A 690V	3	

APPROVALS		14
description	code	note
CE EMC For European Market	0	
CUL us* + CE EMC For American & European Market	L	

LOAD TYPE		15
description	code	note
1 PH Normal Resistance	0	
1 PH IRSW Infrared Short Wave	1	
1 PH MoSi2 Heaters	2	
1 PH SiC Heaters	3	
1 PH Transformer Coupled with Normal Resistance	4	
1 PH Transformer Coupled with MoSi2 Heaters	5	
1 PH Transformer Coupled with SiC Resistance	6	
1 PH Transformer Coupled with UV Lamp	7	

COMMUNICATION AND RETRANSMISSION				16
description	description	code	note	
N°1 Modbus® RTU	No Retransmission	0		
	Retransmission 4:20mA	1		
	Retransmission 0:10V	2		
N°2 Modbus® RTU	No Retransmission	3	4	
	Retransmission 4:20mA	4	4	
	Retransmission 0:10V	5	4	
N°1 Profibus® DP	No Retransmission	6	4	
	Retransmission 4:20mA	7	4	
	Retransmission 0:10V	8	4	
N°1 Profinet® IO	No Retransmission	9	4	
	Retransmission 4:20mA	A	4	
	Retransmission 0:10V	B	4	
N°1 Modbus® TCP	No Retransmission	C	4	
	Retransmission 4:20mA	D	4	
	Retransmission 0:10V	E	4	
N°1 Ethernet IP + N°1 Modbus® RTU	No Retransmission	F	2	
	Retransmission 4:20mA	G	2	
	Retransmission 0:10V	H	2	

- Note (1):** no cUL/UL approved
- Note (2):** Available on unit ≥60A
- Note (3):** Main Supply Voltage has to be included in Auxiliary Voltage range
- Note (4):** 24Vdc Backup Power for User Interface and Communications included
- Note (5):** Only CE and UL approved, not cUL

\*Secondary Input can be configured for external current limit reference, external feedback or secondary input reference. See the manual for more informations.

# REVO C 2PH



SIZE SR10



SIZE SR16



SIZE S14

## Technical Specification

- Dimensions:** See size and dimensions page 8-9
- Load type:** Normal Resistance, Infrared Short, Medium and Long waveform
- Inputs:** 4:20mA, 0:10V, SSR and Modbus® as std and different Field Bus Listed in the Product Coding
- Firing mode:** Burst Firing, Zero Crossing.
- Control Mode:** Voltage, Current and Power or V2 and I2 with additional Transfer to VxI
- Communication:** RS485 port. RTU Modbus® Protocol and other Field Bus available
- USB:** port integrated for configuration in safety mode (No Load and Auxiliary Voltage needed) Unit Powered Through USB
- Approvals:** Comply with EMC, cUL us® 508 listed and cUL® listed
- 100 KA:** Short Circuit Current rating (SCCR) up to 600V

## Option

- See below the types of options and their combination for Code generation
- Energy Totalizer
- Data Logging
- WiFi
- HB Alarm to diagnose partial or Total Load Failure and Thyristor Short Circuit

## Tools

- A very easy and Powerful Configurator Software is available Free of Charge on [www.cdautomation.com](http://www.cdautomation.com)
- CD Automation APP is also available free of charge to communicate via Wi-Fi

No option     Option selected (ex code 3: Logging + Totalizer)

HB	WIFI	LOGGING	TOTALIZER	CODE	NOTES
<input type="checkbox"/>	<input type="checkbox"/>	<input type="checkbox"/>	<input type="checkbox"/>	0	
<input type="checkbox"/>	<input type="checkbox"/>	<input type="checkbox"/>	<input type="checkbox"/>	1	<b>HB</b> Alarm for partial or total load failure and Short Circuit on SCR (relay output).
<input type="checkbox"/>	<input type="checkbox"/>	<input type="checkbox"/>	<input type="checkbox"/>	2	
<input type="checkbox"/>	<input type="checkbox"/>	<input type="checkbox"/>	<input type="checkbox"/>	3	<b>WIFI</b> Option that allows communication with a smart phone. From your smart phone via the CD Automation App, direct to your thyristor unit in the cabinet to read current, voltage, power and energy totalization as well as the ability to change parameters to improve process and product quality without opening the cabinet door.
<input type="checkbox"/>	<input type="checkbox"/>	<input type="checkbox"/>	<input type="checkbox"/>	4	
<input type="checkbox"/>	<input type="checkbox"/>	<input type="checkbox"/>	<input type="checkbox"/>	5	
<input type="checkbox"/>	<input type="checkbox"/>	<input type="checkbox"/>	<input type="checkbox"/>	6	
<input type="checkbox"/>	<input type="checkbox"/>	<input type="checkbox"/>	<input type="checkbox"/>	7	
<input type="checkbox"/>	<input type="checkbox"/>	<input type="checkbox"/>	<input type="checkbox"/>	8	<b>APP</b> Free of charge download it from Google Play or Apple Store.
<input type="checkbox"/>	<input type="checkbox"/>	<input type="checkbox"/>	<input type="checkbox"/>	9	
<input type="checkbox"/>	<input type="checkbox"/>	<input type="checkbox"/>	<input type="checkbox"/>	A	<b>DATA LOGGER</b> This feature is important to see the historical data of parameter like Current, Voltage and Power and can be useful to diagnose a fault.
<input type="checkbox"/>	<input type="checkbox"/>	<input type="checkbox"/>	<input type="checkbox"/>	B	
<input type="checkbox"/>	<input type="checkbox"/>	<input type="checkbox"/>	<input type="checkbox"/>	C	
<input type="checkbox"/>	<input type="checkbox"/>	<input type="checkbox"/>	<input type="checkbox"/>	D	<b>ENERGY TOTALIZER</b> This function totalize the energy consumption of the load allowing the calculation cost of heating treatment.
<input type="checkbox"/>	<input type="checkbox"/>	<input type="checkbox"/>	<input type="checkbox"/>	E	
<input type="checkbox"/>	<input type="checkbox"/>	<input type="checkbox"/>	<input type="checkbox"/>	F	

# CONNECTIVITY

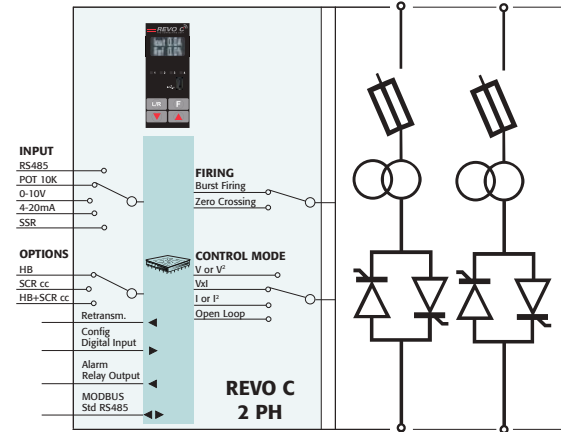
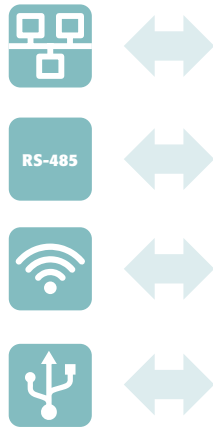

## ORDER CODE:

	<b>1</b>	<b>2</b>	<b>3</b>	<b>4</b>	<b>5</b>	<b>6</b>		<b>7</b>	<b>8</b>	<b>9</b>	<b>10</b>	<b>11</b>	<b>12</b>	<b>13</b>	<b>14</b>	<b>15</b>	<b>16</b>
<b>REVO C 2PH</b>	<b>R</b>	<b>C</b>	<b>2</b>	-	-	-	-	-	-	-	-	-	-	-	-	-	-

CURRENT	FUSES	4	5	6	
description	description	code			note
30A	Fuse + Fuse Holder Included	0	3	0	
35A	Fuse + Fuse Holder Included	0	3	5	
40A	Fuse + Fuse Holder Included	0	4	0	
60A	Fixed Fuses Included	0	6	0	
90A	Fixed Fuses Included	0	9	0	
120A	Fixed Fuses Included	1	2	0	
150A	Fixed Fuses Included	1	5	0	
180A	Fixed Fuses Included	1	8	0	
210A	Fixed Fuses Included	2	1	0	
300A	Fixed Fuses Included	3	0	0	
400A	Fixed Fuses Included	4	0	0	
450A	Fixed Fuses Included	4	5	0	
500A	Fixed Fuses Included	5	0	0	
600A	Fixed Fuses Included	6	0	0	
700A	Fixed Fuses Included	7	0	0	
800A	Fixed Fuses Included	8	0	0	5

For Extended version (from 1100A to 2100A) see page 18

MAX VOLTAGE		7	
description		code	note
480V		4	
600V		6	
690V		7	1,2

MAIN SUPPLY VOLTAGE	AUX VOLTAGE RANGE	8	
	V range	code	note
100/120Vac	90 to 135Vac	1	3
200/208/230/240Vac	180 to 265Vac	2	3
277Vac	238 to 330Vac	3	3
380/415/480Vac	342 to 528Vac	5	3
600Vac	540 to 759Vac	6	3
690Vac	540 to 759Vac	7	3

MAIN INPUT		9	
description		code	note
SSR		S	
0:20mA		B	
4:20mA		A	
0:10V		V	
10KPot		K	

FIRING	START OPTION	10	
description	description	code	note
Burst Firing	No Soft Start	B	
Zero Crossing	No Soft Start	Z	

CONTROL MODE		11	
description		code	note
Open Loop		0	
Voltage		U	
Voltage Square		Q	
Current		I	
Current Square		A	
Power VxI		W	

OPTION		12	
description		code	note
No Option		0	
Option code - see previous page table		...	

FAN VOLTAGE		13	
description		code	note
No Fan < 90A 480V/600V		0	
Fan 115Vac ≥ 90A 480V/600V - ≥ 60A 690V		1	
Fan 230Vac ≥ 90A 480V/600V - ≥ 60A 690V Std Version		2	
Fan 24Vdc ≥ 90A 480V/600V - ≥ 60A 690V		3	

APPROVALS		14	
description		code	note
CE EMC For European Market		0	
CUL us* + CE EMC For American & European Market		L	

LOAD TYPE		15	
description		code	note
Normal Resistive Load with 3 Phase Star without neutral Connection		0	
Normal Resistive Load with 3 Phase Delta Connection		1	
IRSW Infrared Short wave with 3 Phase Star Connection		2	
IRSW Infrared Short wave with 3 Phase Delta Connection		3	

COMMUNICATION AND RETRANSMISSION		16	
description	description	code	note
N°1 Modbus® RTU	No Retransmission	0	
	Retransmission 4:20mA	1	
	Retransmission 0:10V	2	
N°2 Modbus® RTU	No Retransmission	3	4
	Retransmission 4:20mA	4	4
	Retransmission 0:10V	5	4
N°1 Profibus® DP	No Retransmission	6	4
	Retransmission 4:20mA	7	4
	Retransmission 0:10V	8	4
N°1 Profinet® IO	No Retransmission	9	4
	Retransmission 4:20mA	A	4
	Retransmission 0:10V	B	4
N°1 Modbus® TCP	No Retransmission	C	4
	Retransmission 4:20mA	D	4
	Retransmission 0:10V	E	4
N°1 Ethernet IP + N°1 Modbus® RTU	No Retransmission	F	2
	Retransmission 4:20mA	G	2
	Retransmission 0:10V	H	2

- Note (1): No cUL/UL approved
- Note (2): Available on unit ≥60A
- Note (3): Main Supply Voltage has to be included in Auxiliary Voltage range
- Note (4): 24Vdc Backup Power for User Interface and Communications included
- Note (5): Only CE and UL approved, not cUL

# REVO C 3PH



SIZE SR11



SIZE SR17



SIZE S14

## Technical Specification

- Dimensions:** See size and dimensions page 8-9
- Load type:** Normal Resistance, Infrared Short, Medium and Long, Transformer Primary using Phase Angle, Cold resistance and SiC elements
- Inputs:** 4:20mA, 0:10V, SSR and Modbus® as std and different Field Bus Listed in the Product Coding
- Firing mode:** Burst Firing, Delayed Triggering and Phase Angle with or without Soft Start
- Control Mode:** Voltage, Current and Power or V2 and I2 with additional Transfer to VxI
- Communication:** RS485 port. RTU Modbus® Protocol and other Field Bus available
- USB:** port integrated for configuration in safety mode (No Load and Auxiliary Voltage needed) Unit Powered Through USB
- Approvals:** Comply with EMC, cUL us® 508 listed and cUL® listed
- 100 KA:** Short Circuit Current rating (SCCR) up to 600V
- Dual Current Limit:** for peak and RMS value

## Option

- See below the types of options and their combination for Code generation
- Energy Totalizer
- Data Logging
- WiFi
- HB Alarm to diagnose partial or Total Load Failure and Thyristor Short Circuit

## Tools

- A very easy and Powerful Configurator Software is available Free of Charge on [www.cdautomation.com](http://www.cdautomation.com)
- CD Automation APP is also available free of charge to communicate via Wi-Fi

No option     Option selected (ex code 3: Logging + Totalizer)

I LIMIT	HB	WIFI	LOGGING	TOTALIZER	CODE	NOTES
<input type="checkbox"/>	<input type="checkbox"/>	<input type="checkbox"/>	<input type="checkbox"/>	<input type="checkbox"/>	0	
<input type="checkbox"/>	<input type="checkbox"/>	<input type="checkbox"/>	<input type="checkbox"/>	<input type="checkbox"/>	1	
<input type="checkbox"/>	<input type="checkbox"/>	<input type="checkbox"/>	<input type="checkbox"/>	<input type="checkbox"/>	2	
<input type="checkbox"/>	<input type="checkbox"/>	<input type="checkbox"/>	<input type="checkbox"/>	<input type="checkbox"/>	3	
<input type="checkbox"/>	<input type="checkbox"/>	<input type="checkbox"/>	<input type="checkbox"/>	<input type="checkbox"/>	4	
<input type="checkbox"/>	<input type="checkbox"/>	<input type="checkbox"/>	<input type="checkbox"/>	<input type="checkbox"/>	5	
<input type="checkbox"/>	<input type="checkbox"/>	<input type="checkbox"/>	<input type="checkbox"/>	<input type="checkbox"/>	6	
<input type="checkbox"/>	<input type="checkbox"/>	<input type="checkbox"/>	<input type="checkbox"/>	<input type="checkbox"/>	7	
<input type="checkbox"/>	<input type="checkbox"/>	<input type="checkbox"/>	<input type="checkbox"/>	<input type="checkbox"/>	8	
<input type="checkbox"/>	<input type="checkbox"/>	<input type="checkbox"/>	<input type="checkbox"/>	<input type="checkbox"/>	9	
<input type="checkbox"/>	<input type="checkbox"/>	<input type="checkbox"/>	<input type="checkbox"/>	<input type="checkbox"/>	A	
<input type="checkbox"/>	<input type="checkbox"/>	<input type="checkbox"/>	<input type="checkbox"/>	<input type="checkbox"/>	B	
<input type="checkbox"/>	<input type="checkbox"/>	<input type="checkbox"/>	<input type="checkbox"/>	<input type="checkbox"/>	C	
<input type="checkbox"/>	<input type="checkbox"/>	<input type="checkbox"/>	<input type="checkbox"/>	<input type="checkbox"/>	D	
<input type="checkbox"/>	<input type="checkbox"/>	<input type="checkbox"/>	<input type="checkbox"/>	<input type="checkbox"/>	E	
<input type="checkbox"/>	<input type="checkbox"/>	<input type="checkbox"/>	<input type="checkbox"/>	<input type="checkbox"/>	F	
<input type="checkbox"/>	<input type="checkbox"/>	<input type="checkbox"/>	<input type="checkbox"/>	<input type="checkbox"/>	G	
<input type="checkbox"/>	<input type="checkbox"/>	<input type="checkbox"/>	<input type="checkbox"/>	<input type="checkbox"/>	H	
<input type="checkbox"/>	<input type="checkbox"/>	<input type="checkbox"/>	<input type="checkbox"/>	<input type="checkbox"/>	I	
<input type="checkbox"/>	<input type="checkbox"/>	<input type="checkbox"/>	<input type="checkbox"/>	<input type="checkbox"/>	J	
<input type="checkbox"/>	<input type="checkbox"/>	<input type="checkbox"/>	<input type="checkbox"/>	<input type="checkbox"/>	K	
<input type="checkbox"/>	<input type="checkbox"/>	<input type="checkbox"/>	<input type="checkbox"/>	<input type="checkbox"/>	L	
<input type="checkbox"/>	<input type="checkbox"/>	<input type="checkbox"/>	<input type="checkbox"/>	<input type="checkbox"/>	M	
<input type="checkbox"/>	<input type="checkbox"/>	<input type="checkbox"/>	<input type="checkbox"/>	<input type="checkbox"/>	N	
<input type="checkbox"/>	<input type="checkbox"/>	<input type="checkbox"/>	<input type="checkbox"/>	<input type="checkbox"/>	O	
<input type="checkbox"/>	<input type="checkbox"/>	<input type="checkbox"/>	<input type="checkbox"/>	<input type="checkbox"/>	P	
<input type="checkbox"/>	<input type="checkbox"/>	<input type="checkbox"/>	<input type="checkbox"/>	<input type="checkbox"/>	Q	
<input type="checkbox"/>	<input type="checkbox"/>	<input type="checkbox"/>	<input type="checkbox"/>	<input type="checkbox"/>	R	
<input type="checkbox"/>	<input type="checkbox"/>	<input type="checkbox"/>	<input type="checkbox"/>	<input type="checkbox"/>	S	
<input type="checkbox"/>	<input type="checkbox"/>	<input type="checkbox"/>	<input type="checkbox"/>	<input type="checkbox"/>	T	
<input type="checkbox"/>	<input type="checkbox"/>	<input type="checkbox"/>	<input type="checkbox"/>	<input type="checkbox"/>	U	
<input type="checkbox"/>	<input type="checkbox"/>	<input type="checkbox"/>	<input type="checkbox"/>	<input type="checkbox"/>	V	

**I LIMIT (CURRENT LIMIT)** This option is used to keep the overcurrent inside setted limit. It's necessary to drive primary transformers and cold resistance. This option is not available on 30-35-40A units.

**HB** Alarm for partial or total load failure and Short Circuit on SCR (relay output).

**WiFi** Option that allows communication with a smart phone. From your smart phone via the CD Automation App, direct to your thyristor unit in the cabinet to read current, voltage, power and energy totalization as well as the ability to change parameters to improve process and product quality without opening the cabinet door.

**APP** Free of charge download it from Google Play or Apple Store.

**DATA LOGGER** This feature is important to see the historical data of parameter like Current, Voltage and Power and can be useful to diagnose a fault.

**ENERGY TOTALIZER** This function totalize the energy consumption of the load allowing the calculation cost of heating treatment.



# CONNECTIVITY

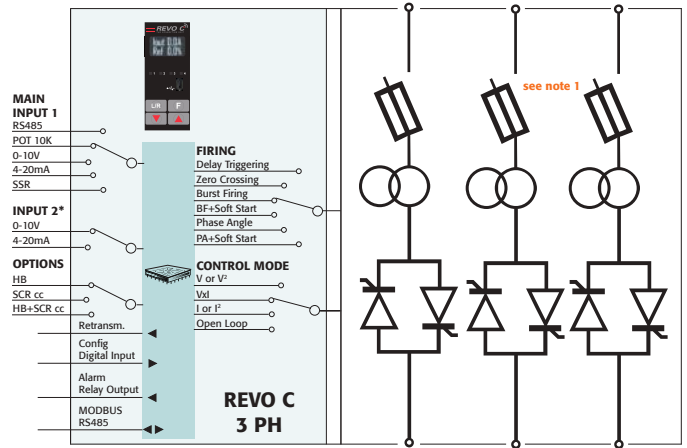
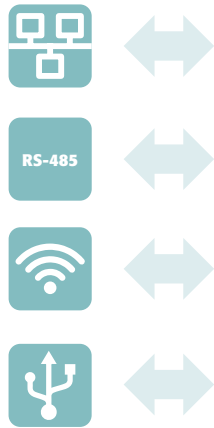

## ORDER CODE:

	<b>1</b>	<b>2</b>	<b>3</b>	<b>4</b>	<b>5</b>	<b>6</b>	<b>7</b>	<b>8</b>	<b>9</b>	<b>10</b>	<b>11</b>	<b>12</b>	<b>13</b>	<b>14</b>	<b>15</b>	<b>16</b>
<b>REVO C 3PH</b>	<b>R</b>	<b>C</b>	<b>3</b>	-	-	-	-	-	-	-	-	-	-	-	-	-

CURRENT	FUSES	4	5	6	
description	description	code		note	
30A	Fuse + Fuse Holder Included	0	3	0	2
35A	Fuse + Fuse Holder Included	0	3	5	2
40A	Fuse + Fuse Holder Included	0	4	0	2
60A	Fixed Fuses Included	0	6	0	
90A	Fixed Fuses Included	0	9	0	
120A	Fixed Fuses Included	1	2	0	
150A	Fixed Fuses Included	1	5	0	
180A	Fixed Fuses Included	1	8	0	
210A	Fixed Fuses Included	2	1	0	
300A	Fixed Fuses Included	3	0	0	
400A	Fixed Fuses Included	4	0	0	
450A	Fixed Fuses Included	4	5	0	
500A	Fixed Fuses Included	5	0	0	
600A	Fixed Fuses Included	6	0	0	5
700A	Fixed Fuses Included	7	0	0	5
800A	Fixed Fuses Included	8	0	0	5

*For Extended version (from 1100A to 2100A) see page 18*

MAX VOLTAGE		7	
description	code		note
480V		4	
600V		6	
690V		7	1

MAIN SUPPLY VOLTAGE	AUX VOLTAGE RANGE	8	
	V range	code	note
100/120Vac	90 to 135Vac	1	3
200/208/230/240Vac	180 to 265Vac	2	3
277Vac	238 to 330Vac	3	3
380/415/480Vac	342 to 528Vac	5	3
600Vac	540 to 759Vac	6	3
690Vac	540 to 759Vac	7	3

MAIN INPUT		9	
description	code		note
SSR	S		
0:20mA	B		
4:20mA	A		
0:10V	V		
10KPot	K		

FIRING	START OPTION	10	
description	description	code	note
Burst Firing	No Soft Start	B	
	Linear Soft Starter	J	
Phase Angle	No Soft Start	P	2
	Linear Soft Starter	E	2
Delayed Triggering	No Soft Start	D	2
	No Soft Start	Z	
Zero Crossing	Linear Soft Starter	R	

CONTROL MODE		11	
description	code		note
Open Loop	0		
Voltage	U		
Voltage Square	Q		
Current	I		
Current Square	A		
Power VxI	W		

OPTION		12	
description	code		note
No Option	0		
Option code - see previous page table	...		

FAN VOLTAGE		13	
description	code		note
No Fan < 90A 480V/600V	0		
Fan 115Vac ≥ 90A 480V/600V - ≥ 60A 690V	1		
Fan 230Vac ≥ 90A 480V/600V - ≥ 60A 690V Std Version	2		
Fan 24Vdc ≥ 90A 480V/600V - ≥ 60A 690V	3		

APPROVALS		14	
description	code		note
CE EMC For European Market	0		
CUL us* + CE EMC For American & European Market	L		

LOAD TYPE		15	
description	code		note
Normal Resistive with 3 Phase Star Connection with neutral	0		
Normal Resistive with 3 Phase Delta or Star Connection	1		
IRSW Infrared Short wave with 3 Phase Star Connection with neutral	2		
IRSW Infrared Short wave with 3 Phase Delta or Star Connection	3		
3 Phase Transformer coupled with normal resistance	4		
3 Phase Transformer coupled with cold resistance	5		

COMMUNICATION AND RETRANSMISSION		16	
description	description	code	note
N°1 Modbus® RTU	No Retransmission	0	
	Retransmission 4:20mA	1	
	Retransmission 0:10V	2	
N°2 Modbus® RTU	No Retransmission	3	4
	Retransmission 4:20mA	4	4
	Retransmission 0:10V	5	4
N°1 Profibus® DP	No Retransmission	6	4
	Retransmission 4:20mA	7	4
	Retransmission 0:10V	8	4
N°1 Profinet® IO	No Retransmission	9	4
	Retransmission 4:20mA	A	4
	Retransmission 0:10V	B	4
N°1 Modbus® TCP	No Retransmission	C	4
	Retransmission 4:20mA	D	4
	Retransmission 0:10V	E	4
N°1 Ethernet IP + N°1 Modbus® RTU	No Retransmission	F	6
	Retransmission 4:20mA	G	6
	Retransmission 0:10V	H	6

\*Secondary Input can be configured for external current limit reference, external feedback or secondary input reference. See the manual for more informations.

**Note (1):** No cUL/UL approved **Note (2):** Phase Angle and Delayed Triggering not available on 30-35-40A  
**Note (3):** Main Supply Voltage has to be included in Auxiliary Voltage range  
**Note (4):** 24Vdc Backup Power for User Interface and Communications included  
**Note (5):** Only CE and UL approved, not cUL **Note (6):** Available on unit ≥60A

# REVO C EXTENDED VERSION

CURRENT	MAX NOMINAL VOLTAGE	MAX NOMINAL VOLTAGE	MAX NOMINAL VOLTAGE
1100A	480V	600V	690V
1400A	480V	600V	690V
1600A	480V	600V	690V
1800A	480V	600V	690V
2100A	480V	600V	690V

## ORDER CODE:

	1	2	3	4	5	6	7	8	9	10	11	12	13	14	15	16
<b>REVO C 1PH</b>	<b>R</b>	<b>C</b>	<b>1</b>	-	-	-	-	-	-	-	-	-	-	-	-	-
<b>REVO C 2PH</b>	<b>R</b>	<b>C</b>	<b>2</b>	-	-	-	-	-	-	-	-	-	-	-	-	-
<b>REVO C 3PH</b>	<b>R</b>	<b>C</b>	<b>3</b>	-	-	-	-	-	-	-	-	-	-	-	-	-

CURRENT	FUSES	4	5	6	
description	description	code			note
1100A	Fixed Fuses Included	1	1	H	
1400A	Fixed Fuses Included	1	4	H	
1600A	Fixed Fuses Included	1	6	H	
1800A	Fixed Fuses Included	1	8	H	
2100A	Fixed Fuses Included	2	1	H	

MAX VOLTAGE		7	
description		code	note
480V		4	
600V		6	
690V		7	1

AUX SUPPLY VOLTAGE	AUX VOLTAGE RANGE	8	
description	description	code	note
100/120Vac	90 to 135Vac	1	
200/208/230/240Vac	180 to 265Vac	2	

MAIN INPUT		9	
description		code	note
SSR		S	
0:20mA		B	
4:20mA		A	
0:10V		V	
10KPot		K	

FIRING	START OPTION	10	
description	description	code	note
Burst Firing	No Soft Start	B	
	Linear Soft Starter	J	4
Phase Angle	No Soft Start	P	4
	Linear Soft Starter	E	4
Delayed Triggering	No Soft Start	D	4
	Linear Soft Starter	T	3
Zero Crossing	No Soft Start	Z	
	Linear Soft Starter	R	4

CONTROL MODE		11	
description		code	note
Open Loop		0	
Voltage		U	
Voltage Square		Q	
Current		I	
Current Square		A	
Power Vxl		W	

OPTION		12	
description		code	note
No Option		0	
Option code - see table pag 12 (1PH), pag 14 (2PH), pag 16 (3PH)		...	

FAN VOLTAGE		13	
description		code	note
Fan 115Vac		1	
Fan 230Vac Std Version		2	

APPROVALS		14	
description		code	note
CE EMC for European Market - IP protection rating = 0		0	
CE EMC for European Market - IP protection rating = 20		1	
UL + CE EMC for US and European Market - IP protection rating = 0		2	
UL + CE EMC for US and European Market - IP protection rating = 20		L	

LOAD TYPE		15	
description		code	note
Normal Resistance		0	
IRSW Infrared Short Wave		1	
MoSi2 Heaters		2	
SiC Heaters		3	
Transformer Coupled with Normal Resistance		4	4
Transformer Coupled with MoSi2 Heaters		5	4
Transformer Coupled with SiC Resistance		6	3
Transformer Coupled with UV Lamp		7	3

COMMUNICATION AND RETRANSMISSION		16	
description	description	code	note
N°1 Modbus® RTU	No Retransmission	0	
	Retransmission 4:20mA	1	
	Retransmission 0:10V	2	
N°2 Modbus® RTU	No Retransmission	3	2
	Retransmission 4:20mA	4	2
	Retransmission 0:10V	5	2
N°1 Profibus® DP + N°1 Modbus® RTU	No Retransmission	6	2
	Retransmission 4:20mA	7	2
	Retransmission 0:10V	8	2
N°1 Profinet® IO + N°1 Modbus® RTU	No Retransmission	9	2
	Retransmission 4:20mA	A	2
	Retransmission 0:10V	B	2
N°1 Modbus® TCP + N°1 Modbus® RTU	No Retransmission	C	2
	Retransmission 4:20mA	D	2
	Retransmission 0:10V	E	2
N°1 Ethernet IP + N°1 Modbus® RTU	No Retransmission	F	2
	Retransmission 4:20mA	G	2
	Retransmission 0:10V	H	2

\*Secondary Input can be configured for external current limit reference, external feedback or secondary input reference. See the manual for more informations.

**Note (1):** No cUL/UL approved  
**Note (2):** 24Vdc Backup Power for User Interface and Communications included  
**Note (3):** Available on 1PH only **Note (4):** Available on 1PH and 3PH only

# FEATURES

View with IP20 protection



Standard Version with IP0



## TECHNICAL SPECIFICATION

OPERATING TEMPERATURE	from 0 to +40°C, over this temperature see derating curve at page 23
MAX VOLTAGE POWER SUPPLY	480V, 600V or 690V
AUXILIARY VOLTAGE SUPPLY	90÷265V, 20 VA power consumption. Fan voltage supply: 230±15% as a standard and 110V on request
ANALOG INPUT	1 main reference, 4÷20mA, 0÷10V, 10KPOT, RS485 port
ANALOG INPUT 2	Secondary reference, 0÷10V, 10KPOT
DIGITAL INPUT	Two optoisolated digital input (12/24Vdc), for Start, Stop, Enable, Calibration, Reset Alarm and External Alarm or other function that can be implemented (ex. Switch from one firing to another)
RELAY OUTPUT	Three configurable relay output and one critical alarm
UNIVERSAL FIRING	One of these firing modes can be configured burst firing BF, delayed triggering and phase angle on 1-3 PH units (see on left page)
COMMUNICATION	RS485 port. Modbus communication plus different FieldBus (see Order Code)
UNBALANCED LOAD	This protection allow to have REVO C working up to 20% of unbalance on one phase
CONTROL MODE	Voltage (V), Current (I), Power (VxI), external feed-back, Voltage Square and Current Square
HEATER BREAK	Alarm to diagnose partial or total load failure and short circuit on thyristor
THERMAL PROTECTION	Thermal switch 1 for Overtemperature Alarms std Thermal switch 2 for Alarm and Trip std

## MAINTAINABILITY IN FUNCTION

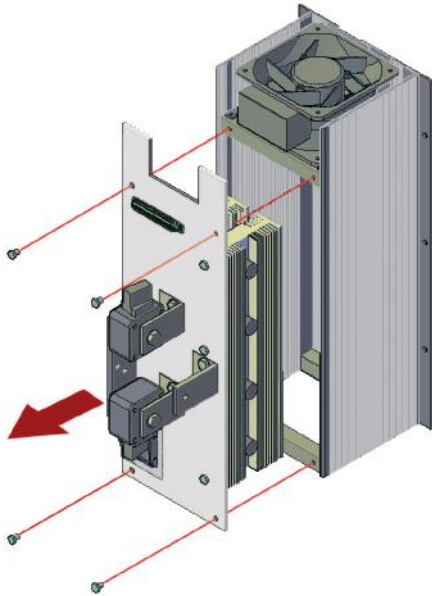

### THESE ARE OUR TARGETS:

- Each phase can be substituted by front unit by technician removing 4 screw without the help of fork lift
- The average weight of phase is 16kg up to 2100 Amps
- Time required to substitute one phase not more than 20 minutes
- Plant downtime not more than 20 minutes, vital for important process
- When the operator replaces one phase, all the auxiliary connection are plug in this allow to be fast and not to make mistakes in the wiring
- Control board plug in for the connection

## HEATER BREAK STANDARD

The heater break circuit diagnostic partial or total load failure.

It reads load resistance with an internal voltage and current transducer to calculate the resistance value  $V/I$ .

The heater break circuit is compensated for voltage fluctuation, in fact a voltage variation has no influence on resistance value because  $V/I$  ratio remain constant.

On this unit is possible to set the nominal resistance and the alarm sensitivity.

HB alarm in addition diagnostic short circuit on thyristor.

A normally open contact gives the alarm condition and an indication of the alarm type.

## FIELDBUS OPTION

- Profibus DP
- Ethernet Modbus TCP protocol
- ProfiNET
- Ethernet IP
- EtherCAT

## REVO KP3 ANCILLARY UNIT



- Graphic operating terminal for thyristor unit up to 6 REVO C can be managed by REVO KP3
- 4.3 - 7.0 - 10" touch colour display are available
- Possibility to see trends of process variable
- Recipe management facility to configure parameter of the unit just touching the panel
- Multi language interface selectable

## CONFIGURATION CABLE

	1	2	3
<b>ORDERING CODE</b>	<b>C</b>	<b>C</b>	<b>X</b>
description	Micro USB Cable for REVEX and REVO C		



**OUR NEW PROJECT**

**OLD FASHION PROJECT**

Aluminum tunnel for cooling	NO ventilation tunnel for cooling
Flux of air in direction of heat sink to increase the cooling efficiency	If you mount more than one unit in a cubicle you will have different air vortex intersection
You buy an units able to grow with your needs including Remote Service	You buy just heat sink plus thyristor
Fuses available inside the units	Fuses not available
Full visual diagnostic via front Key Pad	NO diagnostic
Heater break alarm to diagnostic partial or total load failure and short circuit on thyristor	NO heater break and thyristor short circuit alarm
Fuse fault indication	NO fuse fault indication
Reading on frontal display for current, voltage and power in engineering units	NO reading
Possibility to connect a touch panel to manage up to six units	NO possibility for a touch panel connection because there is not communication
Communication RS485 Std. with Modbus protocol	NO Communicaton
Fieldbus available as option	NO Fieldbus
IP20 protection	NO IP20

# GENERAL FEATURES

## Display Software

0.1	OLED display on front Unit	This display improves the operator interface and delivers use-friendly intuitive messages
0.2	Diagnostic	Powerful diagnostics provides clear alarm notification in plain English on the OLED display
0.3	Fully Software Configurable	REVO C is fully Software configurable
0.4	Layer based Firmware	Layered software design means that new application or customer software can be written without a complete software debug, resulting in faster upgrades and a stable platform

## Electrical Features

1.1	Current rating	30 to 2100A for 1-2-3 Phase unit
1.2	Voltage	480-600-690V 690V only available for unit $\geq 60$ A
1.3	Integrated Fuse	This reduce labor and space and gives the possibility to use a part of fan cooling air to reduce the temperature of semiconductor fuses and reduce the mounting space inside the cabinet (see the comparison at page 11)
1.4	Quick and easy access to Fuses	Fuses and thyristors are mounted directly behind the front panel door
1.5	100 kA Short Circuit Current rating (SCCR) up to 600V	Enable greater protection in case of Short Circuit (see page 6). The unit with cUL have SCCR 100kA

## Firing & Control Mode

2.1	Universal firing mode	Half Cycle, Single Cycle, Burst Firing, Delayed Triggering Phase Angle and Soft Start
2.2	Current Control	This feature is always available for both RMS and peak Control
2.3	Voltage Control	Normally used when Voltage Control Mode is selected
2.4	Power Control	Normally used when Power Control Mode is selected
2.5	Universal Input	The std analog inputs 4:20mA and 0:10V and SSR Configurable via Software - All already calibrated
2.6	Universal Control Mode	REVO C can be configured for Current, Voltage Power feed back or open loop
2.7	External Feed Back	External selection of the Control Mode (Feedback) via 0-10V signal

## Communication

3.1	Wide range of communication protocols	Optional plug-in Field Bus boards to suit application requirements
3.2	Wi Fi	Low cost option that utilizes the Smart Phone App to access Alarm Overview, Configuration and Remote Service & Global Support Service
3.3	Modbus® RTU	Standard
3.4	Modbus® TCP	Option
3.5	Profibus® DP	Option
3.6	Profinet® IO	Option
3.7	USB device on front unit for configuration	Standard easily and safety normally used to configure the REVO C Eliminate the user having to work in a high voltage environment because the unit is powered through USB connection

## Extra Features

4.1	Integrated Data Logging	Storage: 16GB SD memory card with programmable Logging Intervals Optional 40GB SD memory card available
4.2	Energy Counter Totalizer	Available as an option to define the cost per hour of the heating system
4.3	Special Algorithm for Short Wave form IR Lamp	Using half cycle firing and soft start curve to minimize lamp flickering
4.4	Remote service	Available when Wi-Fi and Smart Phone selected Use it and "You will never be alone,"
4.5	Automatic Selection of the configuration as a function of wiring and load type	Automatically select the correct parameters for your application by using the wiring and load type icons via your smart phone or PC configuration software
4.6	HB and Sc Alarm	Alarm for Partial or Total Load Failure and Short Circuit on SCR with Electromechanical Relay output 1A at 30 Vdc or 0,5A at 125 Vac
4.7	Heater Bakeout	Protects heater elements on start-up by eliminating problems caused by moisture ingress
4.8	High precision measurement (True RMS Value for V <sub>I</sub> and V <sub>XI</sub> )	$\leq 1\%$
4.9	Integrate Load Analyzer	Helps the operator to see possible load problems with live Wave Form monitoring
4.10	Free configuration Software	Easy to use and powerful Configurator Software, available free of charge from <a href="http://www.cdautomation.com">www.cdautomation.com</a>

## General Features and Approvals

5.1	Industry-leading and Serviceability	Generous sizing of Thyristors and Thermal Parts using high efficiency Heatsink
5.2	Enable troubleshooting with helpful thermal system diagnostics	Internal temperature sensor detects over-current or high cabinet temperature and raises alarm. If high temperature continues a second high limit alarm stop the thyristor unit
5.3	Fully compatible with obsolete products	Fully upgrade & substitute REVO M, REVO CL and CD3200 units using the same terminal blocks and wiring
5.4	Approvals	CE-EMC and cUL us® 508 Listed up to 700A (1-2PH) and 500A (3PH); UL listed from 800A to 2100A (1-2PH) and 600A to 2100A (3PH); 480-600V versions is available on request CE-EMC only for all 690V Units. See the tab at page 6 for more details

# DERATING CURVE

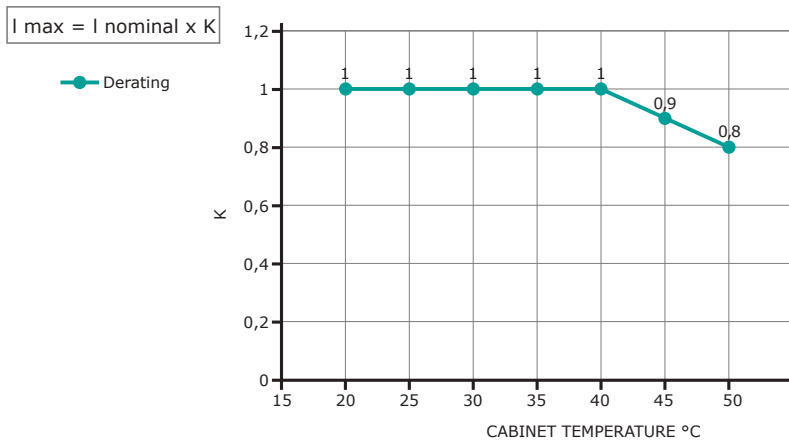

# INTEGRATED FIELDBUS SYSTEM ARCHITECTURE WITH DIFFERENT FIELDBUS CHAIN CONNECTION



# STAR CONNECTION





### **Italy**

CD Automation Srl  
Via Picasso, 34/36  
20025 Legnano MI  
Italy  
**T** +39 0331 577479  
**F** +39 0331 579479  
sales@cdautomation.com  
www.cdautomation.com

### **United Kingdom**

CD Automation UK Ltd  
Unit 9 Harvington Business Park  
Brampton Road, Eastbourne  
East Sussex, BN22 9BN  
England  
**T** +44 1323 811100  
info@cdautomation.co.uk  
www.cdautomation.co.uk

### **India**

M/s Toshcon CD Automation Pvt. Ltd.  
H1 - 75 Gegal Industrial Area  
Ajmer - 305023 (Raj.)  
India  
**T** +91 145 2791112  
**T** +91 145 6450601/2/3  
sales.cd@toshcon.com  
www.cdautomation.in